

Compact digital camera
by choice
see price list 40.24,00

Camera with C-mount

Camera with
SLR-Bajonett

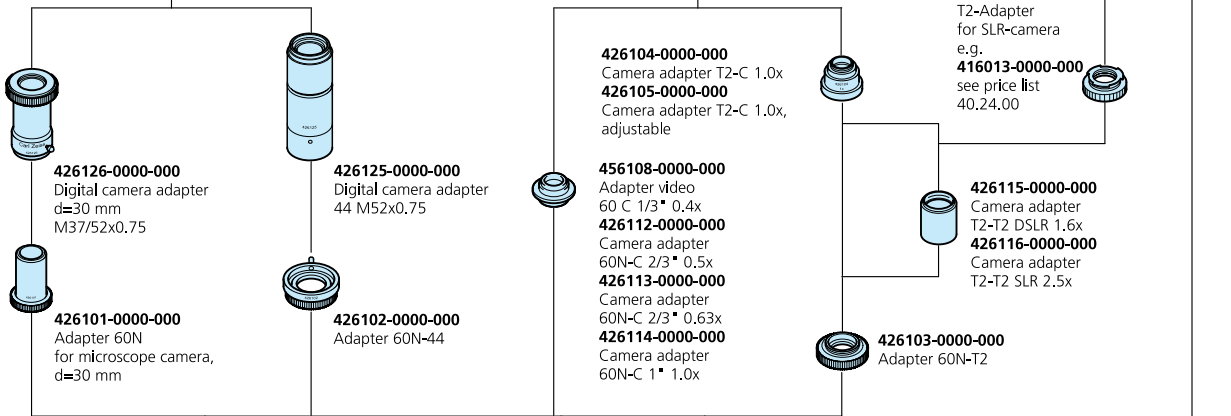

417095-9050-000
Power supply 100...240 V,
50...60 Hz for VisiLED

Camera adapter
for interface 44
see price list 40.24,00

426102-0000-000
Adapter 60N-44

426141-0000-000
Double adapter
60N - 2x 60N 1.0x

Camera adapter
for interface 60
e.g.
456108-0000-000
60 C 1/3 * 0,4x

417095-9000-000
Foot pedal to MC 1500

417095-9000-000
Multiple Controller MC 1500
for VisiLED

417095-9510-000
Holder d=66 mm to VisiLED DF

417095-9255-000
VisiLED ring light S 80-55 BF,
d=66 mm

417095-9500-000
Set for simultaneous fixing
of VisiLED BF+DF

417095-9300-000
VisiLED ring light S 40-10 DF,
d=66 mm

435226-0000-000
Objective Plan Apo S
1.5x FWD 30 mm

435200-0000-000
Objective Plan S
1.0x FWD 81 mm

435202-0000-000
Objective Plan Apo S
0,63x FWD 81 mm

417095-9225-000
VisiLED ring light S 80-25 BF,
d=66 mm

474066-9901-000
Crossline micrometer
10:100, d=26 mm

455043-0000-000
Eyepiece W-PL 10x/23 Br. foc.

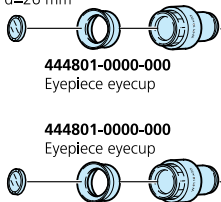

444801-0000-000
Eyepiece eyecup

444801-0000-000
Eyepiece eyecup

434011-0000-000
Micrometer
10:100, d=21 mm

4440540000-000
Eyepiece PL16x/16 Br. foc.

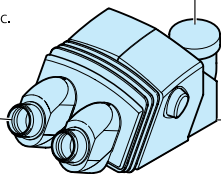

435100-0000-000
Binocular
ergo phototube S
5-45°

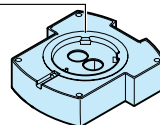

435102-0000-000
Intermediate tube S,
fixed 40 mm

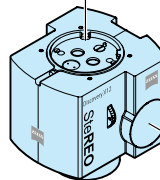

435001-0000-000
SteREO Discovery.V12
microscope body

2 and/or 1

455094-0000-000
Stemij mount with drive
for column 32

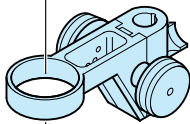

435402-0000-000
Mount S
with diam. 76 mm support

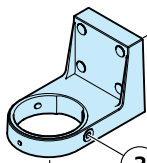

3

435300-0000-000
Objective nosepiece S, 3x, cod.

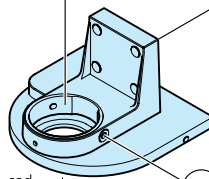

3



434303-0000-000
Dust protection Set M

417095-9050-000
Power supply 100...240 V,
50...60 Hz for VisiLED

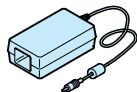

417095-9010-000
Controller MC 750
for VisiLED

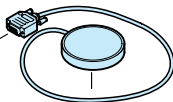

417095-9400-000
VisiLED transillumination BF,
d=84 mm

475290-9901-000
B/W plastic plate,
d=84 mm

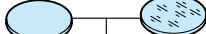

475265-0001-000
Clear glass plate,
d=84 mm



Stage adapter 84/120



Clear glass plate, d=120 mm,
or
B/W plastic plate, d=120 mm

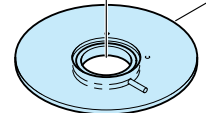
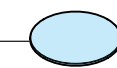

455122-0000-000
Gliding stage

to KL 1500 LCD
or
to KL 2500 LCD

Insert plate

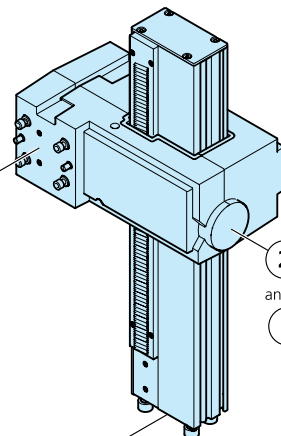
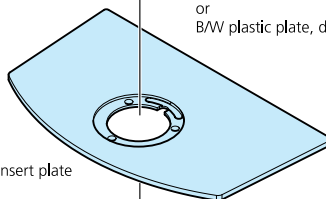

2
and/or
1

435401-0000-000
Focus motor with
Profile S column

435501-0000-000
Transmitted-light equipment S
with
- Clear glass plate, d=120 mm
- Opal glass plate, d=84 mm

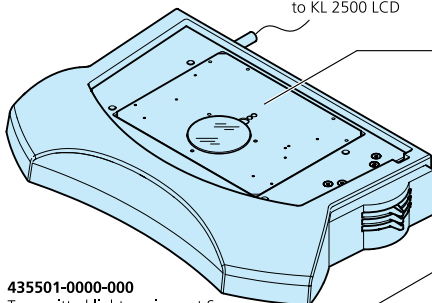

3

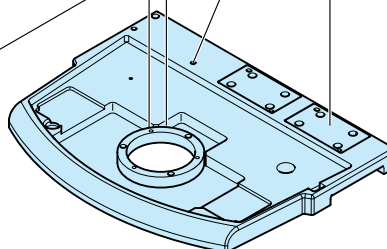

435430-0000-000
Stand base to Profile S
with
- Stage adapter 84/120
- Insert plate
- B/W plastic plate, d=120 mm

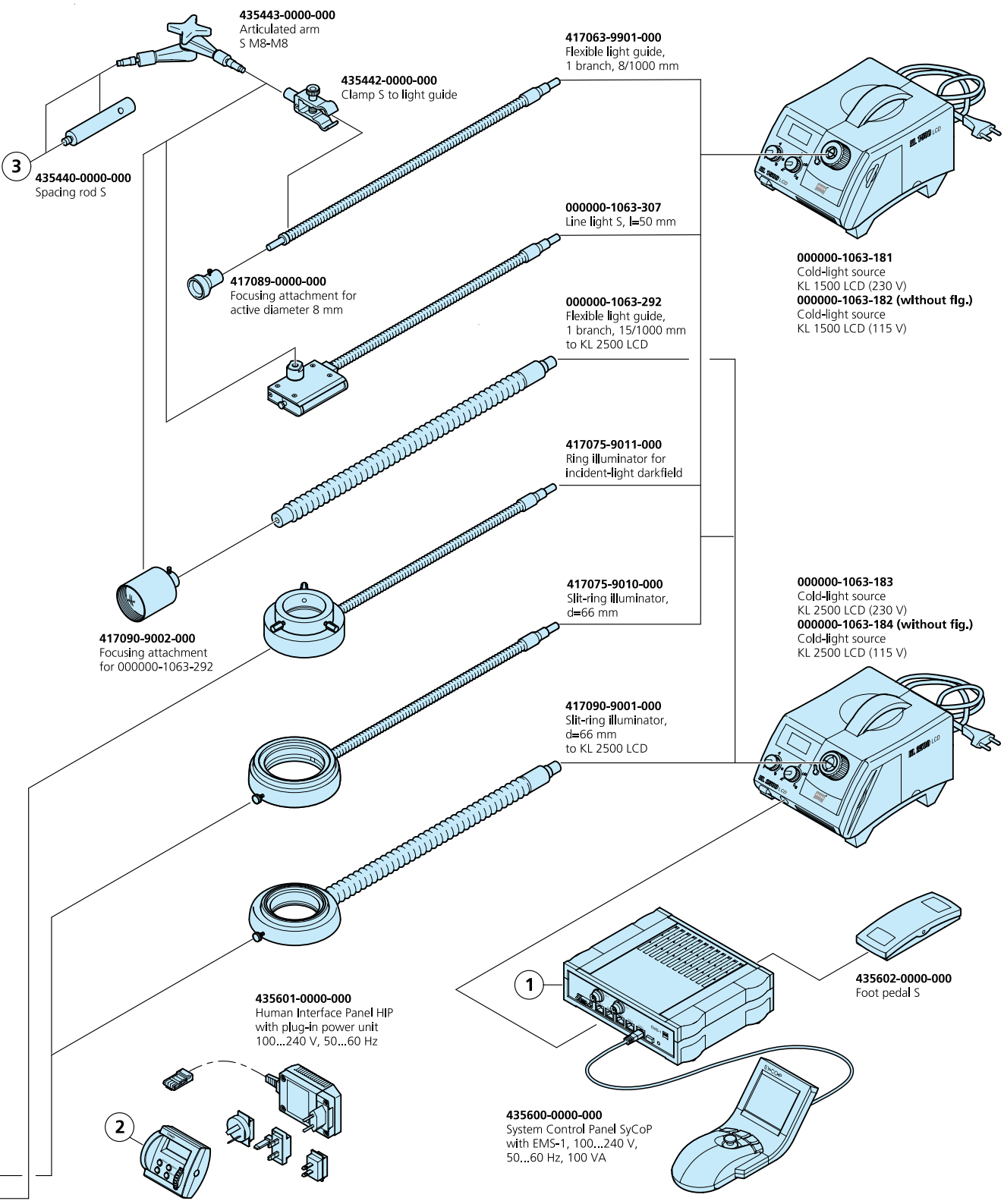

3
435440-0000-000
Spacing rod S

435443-0000-000
Articulated arm
S M8-M8

435442-0000-000
Clamp S to light guide

417063-9901-000
Flexible light guide,
1 branch, 8/1000 mm

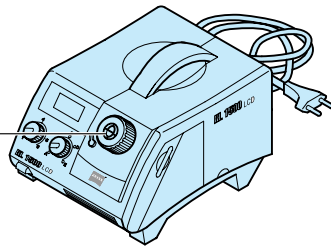

000000-1063-181
Cold-light source
KL 1500 LCD (230 V)
000000-1063-182 (without fig.)
Cold-light source
KL 1500 LCD (115 V)

417089-0000-000
Focusing attachment for
active diameter 8 mm

000000-1063-307
Line light S, l=50 mm

000000-1063-292
Flexible light guide,
1 branch, 15/1000 mm
to KL 2500 LCD

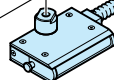

417075-9011-000
Ring illuminator for
incident-light darkfield

417090-9002-000
Focusing attachment
for 000000-1063-292

417075-9010-000
Slit-ring illuminator,
d=66 mm

000000-1063-183
Cold-light source
KL 2500 LCD (230 V)
000000-1063-184 (without fig.)
Cold-light source
KL 2500 LCD (115 V)

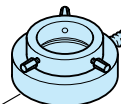

417090-9001-000
Slit-ring illuminator,
d=66 mm
to KL 2500 LCD

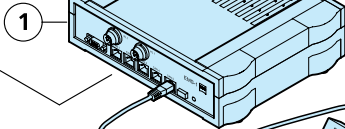
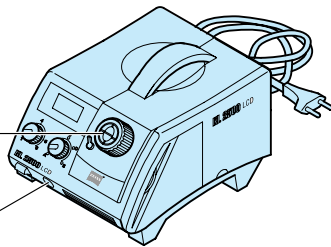

435600-0000-000
System Control Panel SyCoP
with EMS-1, 100...240 V,
50...60 Hz, 100 VA

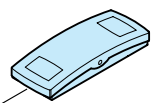

435602-0000-000
Foot pedal S

435601-0000-000
Human Interface Panel HIP
with plug-in power unit
100...240 V, 50...60 Hz

