



## **ZEISS Primostar 3**

Your robust yet compact microscope for digital teaching and routine lab work.

[zeiss.com/primostar](https://zeiss.com/primostar)



Seeing beyond

## Your robust yet compact microscope for digital teaching and routine lab work.

- › In Brief
- › The Advantages
- › The Applications
- › The System
- › Technology and Details
- › Service

In the classroom or in the routine lab, you need reliable microscopes that can take a lot of wear and tear. After all, you and your colleagues or students will be working long hours, often in cramped spaces. You need microscopes that will pay back your investment with smooth operation – day-to-day and year in, year out. Primostar 3 packs all of that into its sturdy metal frame. Yet this robust light microscope is also designed for maximum ease of use. For both productive learning and efficient lab work, students and staff alike will be free from the very beginning to focus on the essentials.

Choose from pre-defined packages for teaching or routine lab work and get the precise microscope configuration you need for the tasks at hand. Each microscope comes pre-installed so it's ready to work right out of the box – that's genuine plug in and play performance. And when you want to take your teaching online or connect your labs on a network, it's easier than ever before with Labscope, the free imaging app from ZEISS.

Primostar 3 is your reliable partner in microscopy – today and in years to come.



*Whether you prefer a basic fixed-Köhler teaching microscope or a dedicated full-Köhler set-up for your lab, ZEISS Primostar 3 comes in pre-defined packages. Choose between ready-to-go combinations.*



# Simpler. More Intelligent. More Integrated.

- › In Brief
- › **The Advantages**
- › The Applications
- › The System
- › Technology and Details
- › Service

## Go for a sound investment

With ZEISS Primostar 3 you're choosing a robust microscope that's designed and built for daily work in a classroom or routine lab. Primostar 3 is made of solid materials so you can rely on a mechanically-stable and resilient microscope. Even after years of daily, intensive use, its components will still be operating smoothly. That built-in durability is reflected in our offering you the benefit of an extended warranty up to five years. Primostar 3 comes in ready-to-use packages, tailored to your application so you can be sure you will have the optimal configuration. Just unwrap it, plug it in and play!

## Tailor your microscope to your tasks

Let your application decide which microscope configuration you choose. The stable design of your full-Köhler version also houses an array of clever features. A 30-watt halogen bulb is interchangeable with an energy-saving LED bulb for stable color temperature and illumination intensity. Or, you can add on a fluorescence tube and turn your Primostar 3 into an LED fluorescence microscope. Contrasting techniques, suitable objective lenses and ports for microscopic documentation are just as you wish. And after a full day's work in the lab, you'll especially appreciate its user-friendly design: the long stage drive lets you work in a relaxed posture, and the double-slider holder boosts efficiency, too.

## Inspire students in your digital classroom

Consider the advantages of having the microscope camera integrated into the tube with a number of digital interface options. Use Labscope, the imaging app from ZEISS, to connect microscopes in your classroom to each other, then share images or videos with your students via HD monitors or projectors. Opt for the software module Labscope Teacher to manage and organize your class. Take advantage of connected microscopes in a digital classroom and gain insights into each and every one through your own iPad or PC. This saves your valuable time for teaching. Then to take your teaching online, simply connect your own microscope with your PC and share your images with all members on the call.



# Tailored Precisely to Your Applications

- › In Brief
- › **The Advantages**
- › The Applications
- › The System
- › Technology and Details
- › Service

## Fixed-Köhler Reliability for Education

Education matters and time for lessons content is always limited. That's why Primostar 3 offers you some very clever details to make your teaching as productive as possible. Fixed-Köhler versions of Primostar 3 come pre-adjusted with a field of view of 20 mm. Selected objective lenses and eyepieces are already in place. Simply plug in your microscope and start your lesson. And here's another plus: long-lasting LED illumination saves energy in your classroom. You want to place your microscope into your storage cabinet? Carry it securely by the handle.



### LED light band

Check the status of the microscope's illumination at a glance – even from a distance.

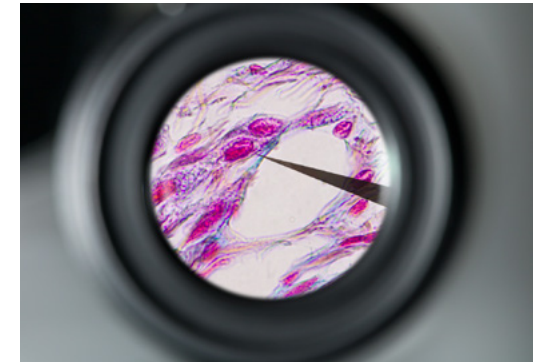

### Optional eyepiece pointer

This useful accessory is inserted into the eyepiece, like a reticle, for marking specific object details in the eyepiece image. Retrofittable.



### 5V USB port

Use the port at the back of the fixed-Köhler stand to connect a power bank or charge your mobile device.



### Cable storage

All cables are neatly stored at the microscope.



# Tailored Precisely to Your Applications

- › In Brief
- › **The Advantages**
- › The Applications
- › The System
- › Technology and Details
- › Service

## **ZEISS Primostar 3 in teaching and routine labs**

Efficiency in teaching and lab work is key. Full-Köhler versions of Primostar 3 with field of view 22 mm give freedom to teach while using Köhler illumination. In pre-defined packages, a selection of objective lenses and eyepieces are already in place. Benefit from a relaxed posture for day-long work with enlarged stage drive. If you have more specimens in place, you can use

the double slider holder. The light manager offers you the same light intensity level over all magnifications. Additional plus: the ECO mode saves you energy and therefore helps to reduce lab costs. You aim for more comfort for your routine lab work? Then choose Primostar 3 with integrated turret condenser and have brightfield, darkfield and phase contrast techniques at hand.



### **Condenser turret**

Switch easily between different contrasting techniques such as brightfield, phase contrast or darkfield.



### **Light manager**

Activate the light manager when changing lenses and the microscope will remember the precise amount of light set for each lens position.



### **ECO mode**

If activated, the microscope will go into a sleep mode if you don't touch it for 30 minutes.



### **Lamp housing**

Use either a 30-watt halogen bulb or an energy-saving 3W-LED illumination offering stable color temperature and illumination intensity. They are interchangeable.

# Expand Your Possibilities

- › In Brief
- › **The Advantages**
- › The Applications
- › The System
- › Technology and Details
- › Service

## Digital Classroom

Bring on the next generation of scientists in your digital classroom. Use the ZEISS Labscope app to connect all your students' microscopes plus WiFi cameras and create a collective learning experience. As a teacher, you can monitor all of their microscopes at a glance. You can see how your students are progressing right in front of your eyes and support them individually where needed. When you see an image of particular relevance on a microscope in the network, share it with the whole group via a projector or monitor. Let this be where a more interactive learning experience opens up your face-to-face teaching.

Primostar 3 with its integrated 8.3 MPx HD WiFi-camera is the package of choice for digital classrooms. This camera offers versatile interfaces such as LAN, HDMI, Ethernet and USB-C 3.0. As an added bonus, integrated powering saves you from a jumble of cables. If you prefer microscopes with external camera adaptation, this package will also suit your purposes.

Both options pave your way to live online teaching and learning. Simply connect your microscope or WiFi-camera to your PC and share what you see with the members on your call.



# Expand Your Possibilities

- › In Brief
- › **The Advantages**
- › The Applications
- › The System
- › Technology and Details
- › Service

## ZEISS Labscope

Use Labscope, the imaging app from ZEISS, to display all the live images from your connected microscopes. Select any student's image with just one click. Record images and videos with the high resolution of 8.3 megapixels. You can annotate your images and, for example, measure distances. Then share your images, reports and videos with others via email, social media or cloud services. Labscope lets you save your images in the ZEN compatible .czi file format which includes all metadata and a separate annotation layer. Or select the .jpg format to save space. Downloading Labscope is fast and simple. And it's free.

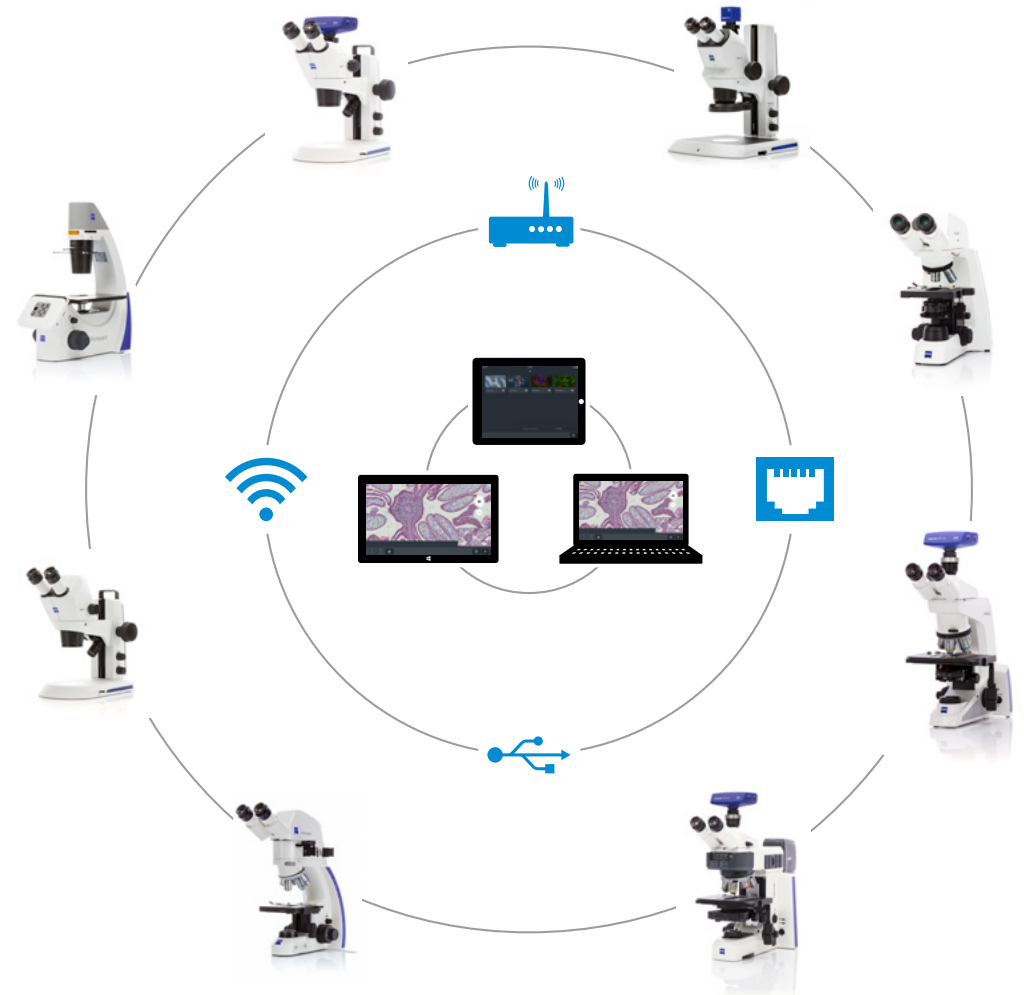

# Expand Your Possibilities

- › In Brief
- › **The Advantages**
- › The Applications
- › The System
- › Technology and Details
- › Service

## ZEISS Labscope

Labscope is your easy-to-use imaging app for connected microscopes. Whether for the routine lab, university or school, or even as a hobby – Labscope lets you snap images, record videos and measure your microscopic samples – easier than ever before.



*Start your journey in digital and interactive teaching with all students' microscopes right in front of your eyes.*

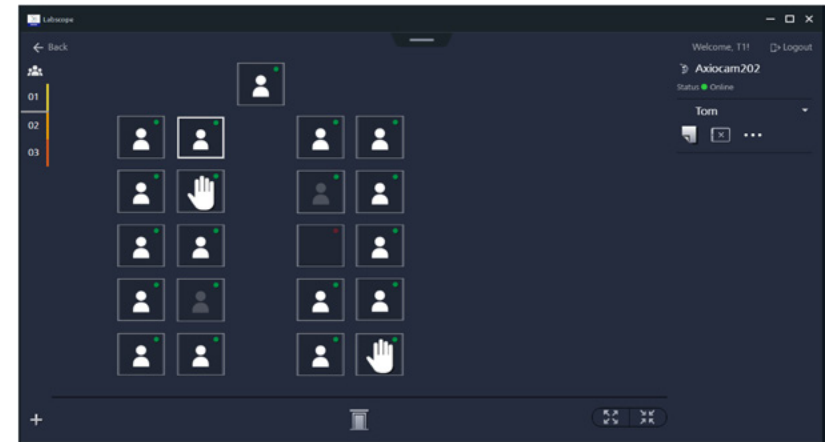

*Labscope Teacher helps you manage your digital classroom.*

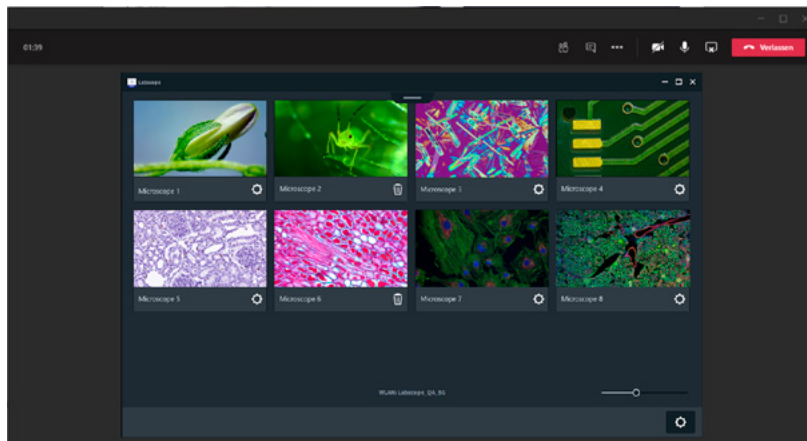

*This is the home or hybrid schooling in microscopy education: students connected to the live image of your microscope via Teams.*



*No artistic skills required to make hand drawings of a microscopy image. This translucent sketch solution supports an inspiring learning style.*



# Expand Your Possibilities

- › In Brief
- › **The Advantages**
- › The Applications
- › The System
- › Technology and Details
- › Service



## Photo tube

Document your microscope images with the photo tube and a microscope camera.



## Swiveling mirror (for fixed-Köhler stands only)

This well-known and popular accessory lets you use your microscope with ambient light or sunlight – no electricity required.



## Transport case

Protect and transport your ZEISS Primostar 3 with the dedicated case.



## Polarizing contrast

Each stand can be equipped quickly with a polarizer and analyzer for polarizing contrast in transmitted light.



## Fluorescence tube

Add on a fluorescence tube and turn your Primostar 3 into an LED fluorescence microscope.

# Tailored Precisely to Your Applications

- › In Brief
- › The Advantages
- › **The Applications**
- › The System
- › Technology and Details
- › Service

## Package Overview

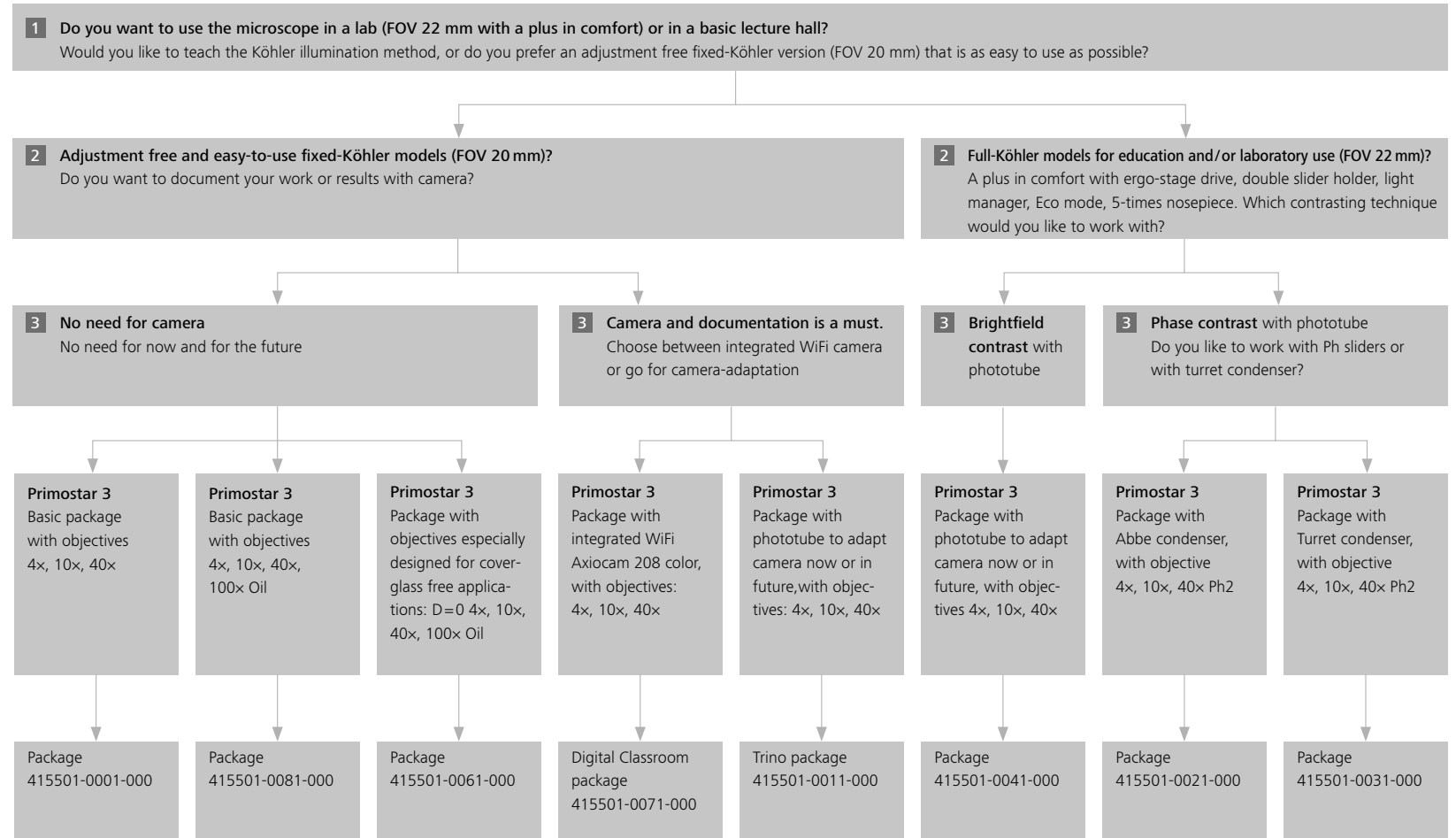

# Tailored Precisely to Your Applications

- › In Brief
- › The Advantages
- › **The Applications**
- › The System
- › Technology and Details
- › Service

Order Number	Primostar 3: 415501-0081-000	Primostar 3: 415501-0001-000	Primostar 3: 415501-0011-000	Primostar 3: 415501-0071-000	Primostar 3: 415501-0061-000	Primostar 3: 415501-0041-000	Primostar 3: 415501-0021-000	Primostar 3: 415501-0031-000
<b>Viewing angle</b>	25°	25°	25°	25°	25°	25°	25°	25°
<b>Stage drive right</b>	x	x	x	x	x	x	x	x
<b>FOV 20 mm</b>	x	x	x	x	x			
<b>FOV 22 mm</b>						x	x	x
<b>Fixed-Köhler</b>	x	x	x	x	x			
<b>Full-Köhler</b>						x	x	x
<b>HAL</b>						x	x	x
<b>LED</b>	x	x	x	x	x	x	x	x
<b>Pointer</b>	x	x	x					
<b>Phototube</b>			x			x	x	x
<b>4times nosepiece</b>	x	x	x	x	x			
<b>5times nosepiece</b>						x	x	x
<b>Objectives D = 0</b>					4x, 10x, 40x, 100x Oil			
<b>Objectives ∞ / 0.17</b>	4x, 10x, 40x, 100x Oil	4x, 10x, 40x	4x, 10x, 40x	4x, 10x, 40x		4x, 10x, 40x	4x, 10x, 40x Ph2	4x, 10x, 40x Ph2
<b>Abbe condensor</b>	x	x	x	x	x	x	x	
<b>Turret condensor</b>								x
<b>Light manager</b>						x	x	x
<b>Eco mode</b>						x	x	x

# Tailored Precisely to Your Applications

- › In Brief
- › The Advantages
- › **The Applications**
- › The System
- › Technology and Details
- › Service

Typical applications, typical samples	Task	ZEISS Primostar 3 offers
<b>Histology</b> <b>Histopathology</b> <b>Microscopic Anatomy</b>	<p>Students need to acquire detailed knowledge of microscopic structure, form and function of cells, tissues, and organs.</p> <p>Each student learn to sketch histological slides and to identify its characteristics by visual microscopic inspection. This to finally justify diagnosis.</p>	<p>Fixed-Köhler packages:            Primostar 3: 415500-0081-000 with 4x, 10x, 40x, 100x Oil</p> <p>Fixed-Köhler packages with camera option (trinotube):            Primostar 3: 415501-0011-000 with 4x, 10x, 40x</p> <p>Fixed-Köhler package with integrated camera:            Primostar 3: 415501-0071-000 with 4x, 10x, 40x</p> <p>Full-Köhler package with camera option (trinotube):            Primostar 3: 415501-0041-000 with 4x, 10x, 40x</p>
<b>Cell Biology</b>	<p>Students need to acquire detailed knowledge of cell structures, cell components, their forms and functionalities.</p> <p>Basic knowledge in cell biology is an important prerequisite for early detection of uncontrolled cell growth in cancer, for example, and for research into the development and treatment of cancer.</p>	<p>Full-Köhler package with phase contrast and camera option (trinotube):</p> <p>Primostar 3:            415501-0021-000 with 4x, 10x, 40x Ph2 (Ph-slider)</p> <p>Primostar 3:            415501-0031-000 with 4x, 10x, 40x Ph2 (turret condenser)</p>
<b>Food Microbiology</b>	<p>Healthy nutrition is important for well-being. New food designs with additives such as lactic acid bacteria or yeasts (so-called probiotics) want to make food even healthier.</p> <p>The composition of the different food additives is key for the positive effect of the food design. The additives, like bacteria, can be detected under the microscope.</p>	<p>Primostar 3: 415501-0031-000 with 4x, 10x, 40x Ph2            iPlan-Achromat 100x Oil Ph3: 415501-1645-000            Darkfield slider: 415501-1802-000            Camera AxioCam 208 color: 426570-9000-000            Camera adapter P95-C ⅔" 0.65x: 415501-1810-000</p>
<b>Medical Microbiology</b>	<p>Bacterias can cause numerous diseases, that is why medical lab technicians need to identify the different bacteria correctly. This is pre-requisite to judge on further treatment of the patient.</p> <p>Gram-staining helps to classify between gram-positive (e.g. Staphylococcus, Streptococcus) and gram-negative bacteria (e.g. Enterobacteriaceae). Their different morphology can be visualized under the microscope.</p>	<p>Primostar 3: 415501-0041-000 with 4x, 10x, 40x            iPlan-Achromat 100x Oil: 415501-1641-000</p> <p>Camera AxioCam 208 color: 426570-9000-000            Camera adapter (P95-C ⅔" 0.65x): 415501-1810-000</p>
<b>Hematology</b>	<p>Blood cells consists of erythrocytes (red blood cells), leukocytes (white blood cells) and platelets (thrombocytes). They all have specific forms and functions, e.g. in transporting oxygen, protecting against blood loss and fighting infections.</p> <p>In stained blood cells under the microscope, the different blood cells and their pathogenic changes can be visualized, blood cells can be counted and also blood differential tests can be made.</p>	<p>Full-Köhler package with camera option (trinotube):            Primostar 3: 415501-0041-000 with 4x, 10x, 40x            Primostar 3: 415501-0061-000 with 10x, 20x, 40x 100x Oil, D=0</p> <p>Accessories:            iPlan-Achromat 100x Oil: 415501-1641-000            Darkfield slider: 415501-1802-000            Camera AxioCam 208 color: 426570-9000-000            Camera adapter (P95-C ⅔" 0.65x): 415501-1810-000</p>



# Tailored Precisely to Your Applications

- › In Brief
- › The Advantages
- › **The Applications**
- › The System
- › Technology and Details
- › Service

Typical applications, typical samples	Task	ZEISS Primostar 3 offers
<b>Gynecology</b>	<p>In women healthcare, changes in vaginal discharge can indicate infection with yeast, bacteria, parasite <i>Trichomonas vaginalis</i> or other pathological processes.</p> <p>The composition of the vaginal fluid can be examined under a microscope. To identify the different microorganism, phase contrast is the method of choice.</p>	<p>Full-Köhler package with camera option (trinotube):            Primostar 3: 415501-0021-000 with 4x, 10x, 40x Ph2 (Ph-slider)            Primostar 3: 415501-0031-000 with 4x, 10x, 40x Ph2 (Turret condenser)</p> <p>Accessories:            iPlan-Achromat 100x Oil: 415501-1641-000            iPlan-Achromat 20x: 415501-1622-000            Camera Axiocam 208 color: 426570-9000-000            Camera adapter (P95-C 2/3" 0.65x): 415501-1810-000</p>
<b>Plantbiology Ecology Agriculture</b>	<p>From plants to food. Plants play a growing role as food for humans and animals, especially in view of the growing population worldwide.</p> <p>Studying plant morphology, plant physiology, reliable detection and classification of plant pests and diseases (phytopathology), diagnosis of malnutrition and pathogenic organisms as pre-requisite to decide about successful plant treatment.</p>	<p>Fixed-Köhler package with integrated camera:            Primostar 3: 415500-0071-000 with 4x, 10x, 40x</p> <p>Full-Köhler package with camera option (trinotube):            Primostar 3: 415501-0041-000 with 4x, 10x, 40x            Camera Axiocam 208 color: 426570-9000-000            Camera adapter (P95-C 2/3" 0.65x): 415501-1810-000</p>
<b>Sputum detection</b>	<p>Lab technicians need to identify <i>Mycobacterium tuberculosis</i> as fast as possible. Gold standard is Ziehl-Neelsen staining and brightfield microscopy.</p> <p>In fluorescence excitation, Mycobacterium tuberculosis can be identified up to 4 times faster, with up to 30 % higher sensitivity. Auramine-O-stained bacilli are easy to detect as glowing tubercle in front of a dark background.</p>	<p>Primostar 3: 415501-0061-000 with 10x, 20x, 40x 100x Oil, D=0</p> <p>Accessory:            Fluorescence intermediate tube iLED 455nm: 415501-1820-000</p>

# ZEISS Primostar 3 at Work

- › In Brief
- › The Advantages
- › **The Applications**
- › The System
- › Technology and Details
- › Service

## Hair follicle of mouse

- Brightfield contrast
- Magnification: 4x, 10x, 40x

Recommended package:

- Package 415501-0001-000:  
Primostar 3 Fixed-Köhler
- Package 415501-0011-000:  
Primostar 3 Fixed-Köhler with camera port
- Package 415501-0041-000:  
Primostar 3 Full-Köhler with camera port

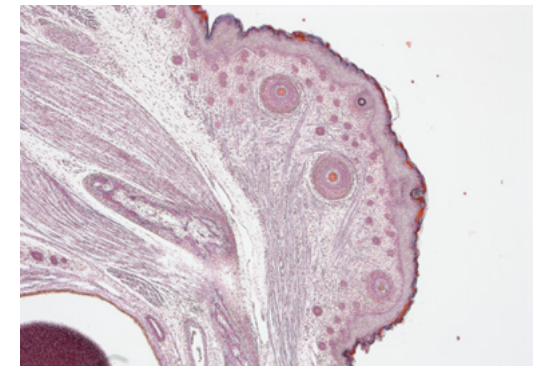
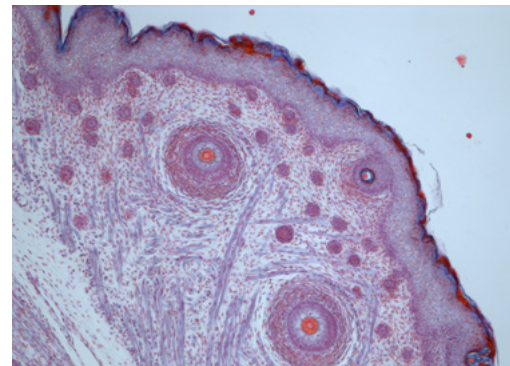
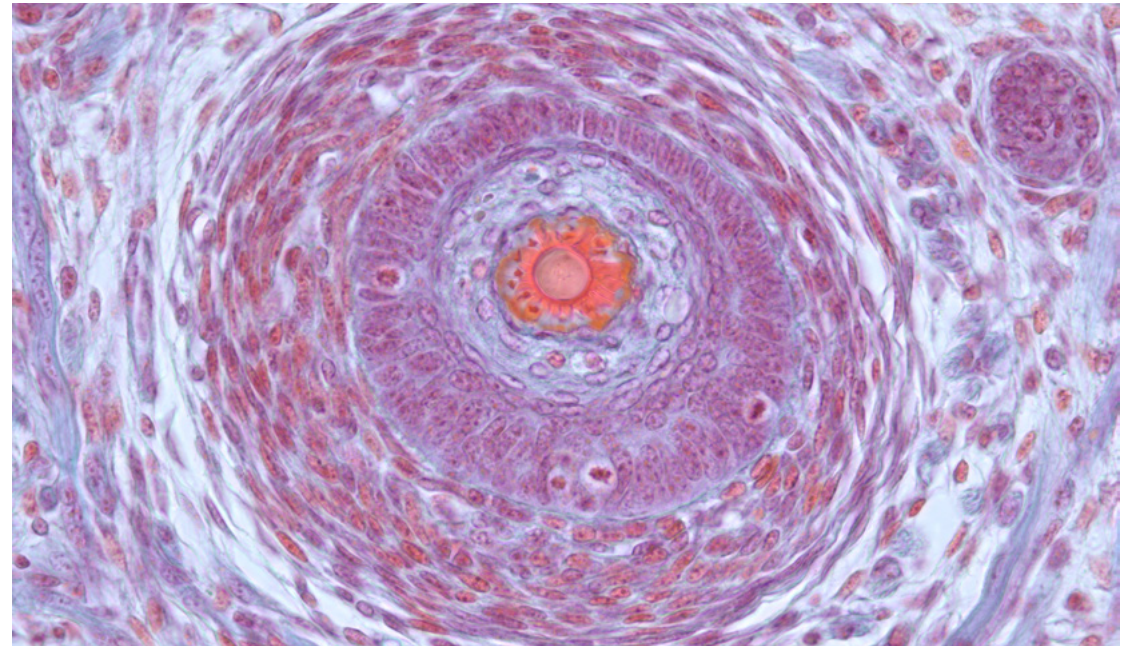

# ZEISS Primostar 3 at Work

- › In Brief
- › The Advantages
- › **The Applications**
- › The System
- › Technology and Details
- › Service

## **Convallaria majalis**

- Brightfield & fluorescence contrast
- Magnification: 4x, 10x

Recommended package:

- Package 415501-0041-000  
Primostar 3 Full-Köhler with intermediate  
Fluorescence tube (415501-0022-000) for  
FITC stained specimen



Convallaria in brightfield, magnification: 4x



Convallaria in brightfield, magnification: 10x

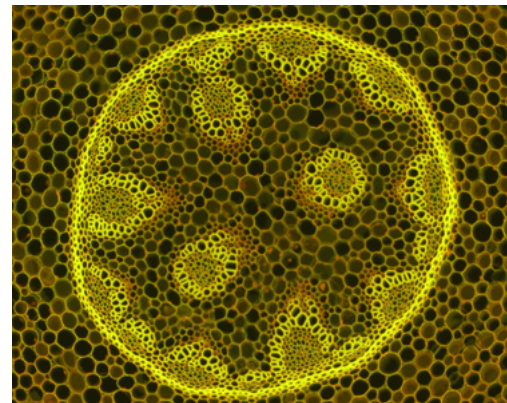

Convallaria in fluorescence contrast, blue 09 and blue 38, magnification: 10x

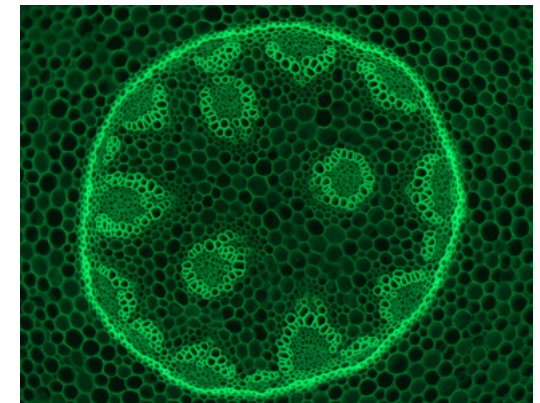



# ZEISS Primostar 3 at Work

- › In Brief
- › The Advantages
- › **The Applications**
- › The System
- › Technology and Details
- › Service

## Tongue of rabbit, taste buds

- Brightfield & phase contrast
- Magnification: 40x

Recommended package:

- Package 415501-0021-000:  
Primostar 3 Full-Köhler with phase contrast
- Package 415501-0031-000:  
Primostar 3 Full-Köhler with phase contrast  
and turret condenser

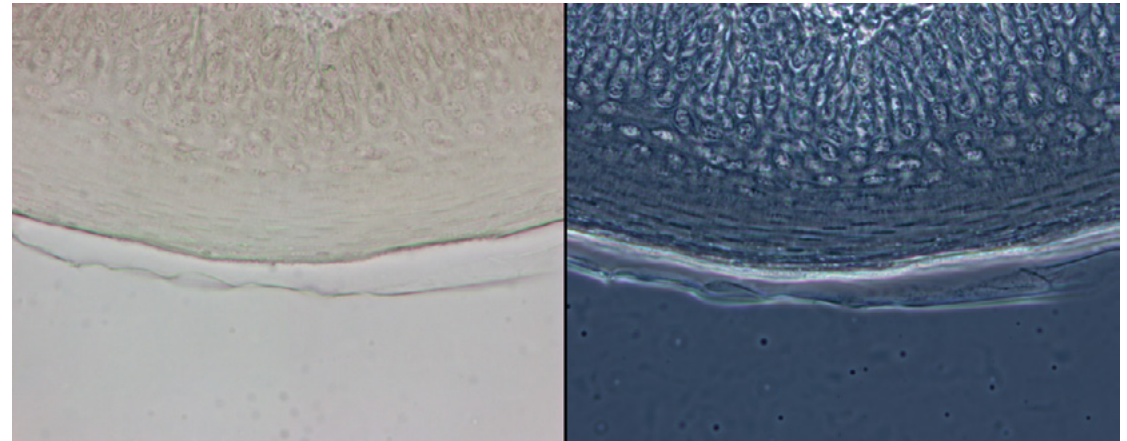

*Taste buds in brightfield and phase contrast, magnification: 40x*

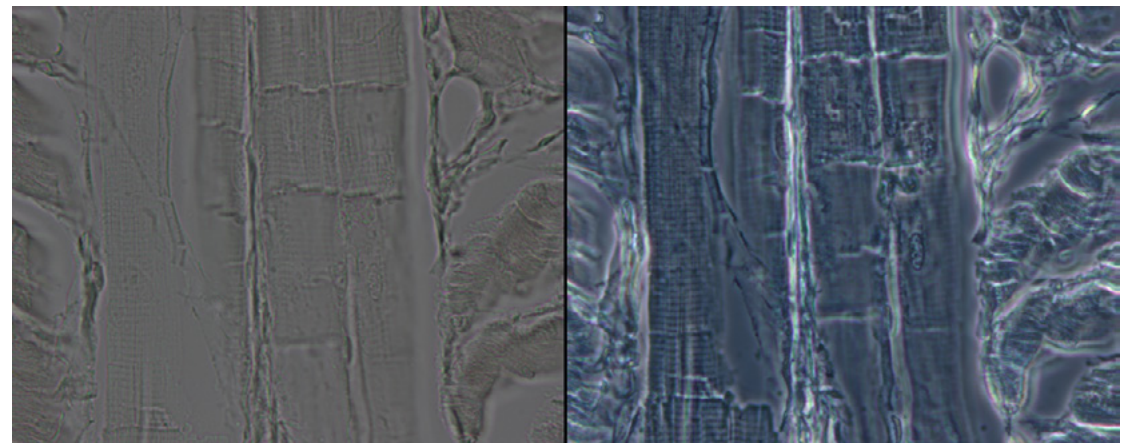

*Taste buds in brightfield and phase contrast, magnification: 40x*



# Your Flexible Choice of Components

- › In Brief
- › The Advantages
- › The Applications
- › **The System**
- › Technology and Details
- › Service



ZEISS Primostar 3 Fixed-Köhler versions

ZEISS Primostar 3 Full-Köhler versions

## 1 Microscope

- Primostar 3 Fixed-Köhler  
FOV=20, 4 position nosepiece, LED, with or without handle
- Primostar 3 Full-Köhler  
(FOV=22, 5 position nosepiece, LED/HAL, ECO mode, Light manager, long stage drive, double slider holder)

## 2 Objectives

- iPlan Achromat 4x/10x/20x/40x/100x Oil
- iPlan-Achromat Ph 10x/20x/40x/100x Oil
- iPlan-Achromat D=0 10x/20x/40x/100x Oil

## 3 Eyepieces

- Eyepiece 10x/20 Br. Foc.
- Eyepiece 10x/22 Br. Foc.

## 4 Condensers

- Condenser Abbe 0.9/1.25  
with slot (sliders for Ph and/or DF)
- Turret condenser BF/Ph1/Ph2/Ph3/DF

## 5 Illumination

- Transmitted light halogen 6V 30W  
(only full-Köhler stands)
- Transmitted light LED 3W 5600K
- Reflected light FI iLED\*  
(455 nm + FS 67 or 470 nm + FS 09)

## 6 Cameras

- Axiocam 208 color (recommended camera)
- Binocular tube HD 25°/22 w/int cam 8MPx\*

## 7 Software

- Labscope imaging app
- ZEN Imaging Software

## 8 Further accessories

- Transmitted light mirror
- Eyepiece pointer
- Crossline micrometer
- Simple polarization accessory
- Transport and storage cases

\* Only for stands without handle

# System Overview

- › In Brief
- › The Advantages
- › The Applications
- › **The System**
- › Technology and Details
- › Service

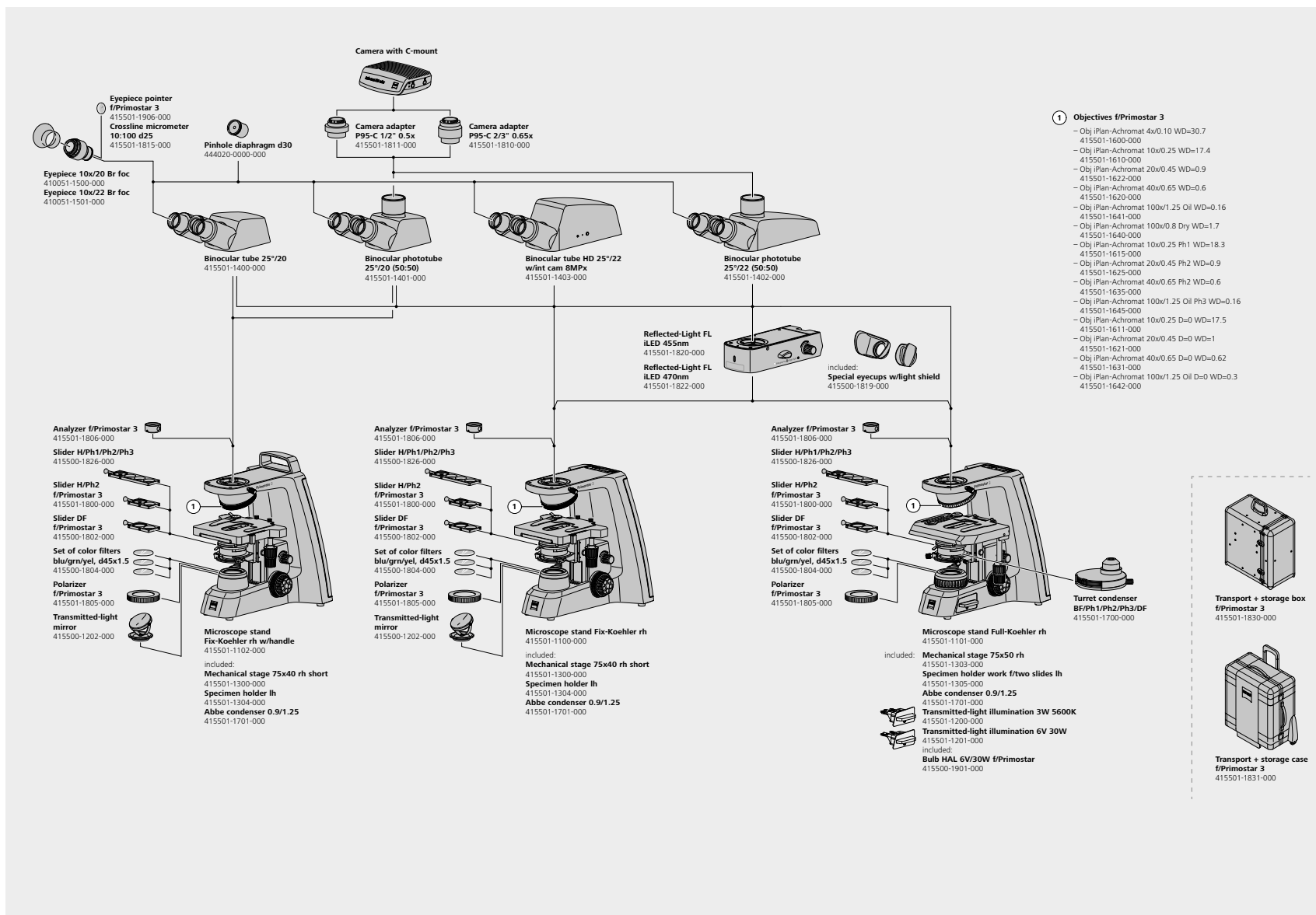

# Technical Specifications

- › In Brief
- › The Advantages
- › The Applications
- › The System
- › **Technology and Details**
- › Service

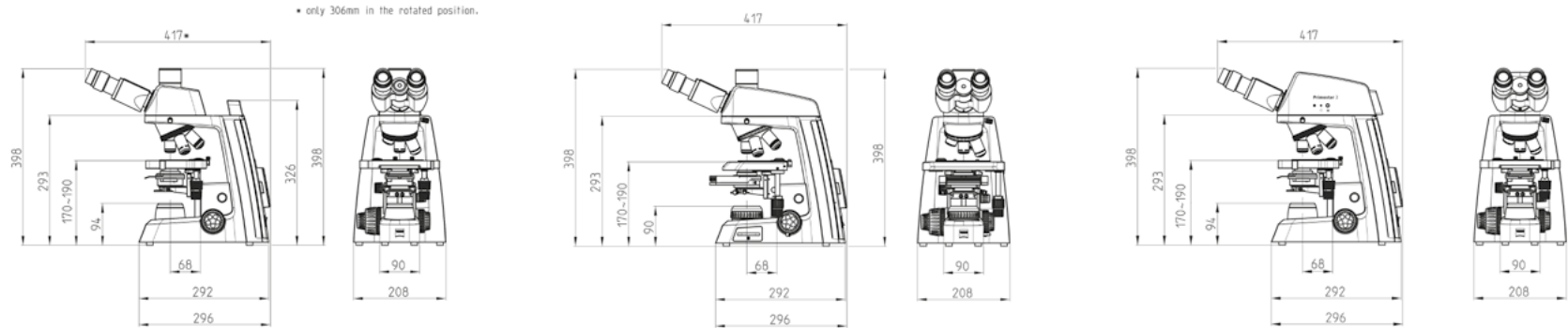

## Dimensions (width × depth × height)

Systems with fixed-Köhler stands	approx. 208 mm × 296 mm × 398 mm	(with reflected light FL iLED intermediate tube approx. 208 mm × 296 mm × 453 mm)
Systems with full-Köhler stands	approx. 208 mm × 296 mm × 398 mm	(with reflected light FL iLED intermediate tube approx. 208 mm × 296 mm × 453 mm)
Systems with Binocular tube HD 25°/20 w/int cam 8MPx	approx. 208 mm × 296 mm × 398 mm	(with reflected light FL iLED intermediate tube approx. 208 mm × 296 mm × 453 mm)

## Weight

Systems with fixed-Köhler stands	approx. 8.5 – 10.5 kg *
Systems with full-Köhler stands	approx. 9.4 – 11.4 kg *
Systems with binocular tube HD 25°/20 w/int cam 8MPx	approx. 9.6 – 12.0 kg *

\* Depending on configuration

# Technical Specifications

- › In Brief
- › The Advantages
- › The Applications
- › The System
- › **Technology and Details**
- › Service

## Ambient conditions

### Transportation (in packaging):

Permissible ambient temperature -40 °C to +70 °C

### Storage:

Permissible ambient temperature +10 °C to +40 °C

Permissible air humidity (no condensation) max. 75 % at 35 °C

### Operation:

Permissible ambient temperature +10 °C to +40 °C

Permissible air humidity (no condensation) max. 75 % at 35 °C

Atmospheric pressure 800 hPa to 1060 hPa

Installation site Exclusively inside buildings

Altitude max. 2000 m

## Operating data

Protection class II

Protection type IP20

Electrical safety in compliance with DIN EN 61010-1 (IEC 61010-1) including CSA and UL directives

Pollution degree 2

Overvoltage category II

Radio interference suppression in accordance with EN 61326

Line voltage 100 to 240 V (±10 %) wide-range input power supply,  
i.e. voltage setting of the instrument need not be changed!

Line frequency 50 / 60 Hz

Power consumption 70 VA; secondary voltage of external power supply 12 V

Plug-in power unit output 12 V DC; max. 2.5 A

Microscope 12 V / 6 V DC adjustable from 1.5 V to 6 V

LED class of complete device 3B



# Technical Specifications

- › In Brief
- › The Advantages
- › The Applications
- › The System
- › **Technology and Details**
- › Service

## Mechanical and optical data

Stand with specimen stage and focusing device	Fixed-Köhler stand	Full-Köhler stand
Coarse focusing drive	45 mm/rev.	45 mm/rev.
Fine focusing drive	0.5 mm/rev.	0.5 mm/rev.
Fine focusing drive	0.5 mm/rev.	0.5 mm/rev.
Total stage lift	15 mm	15 mm
Specimen stage	Mechanical rackless stage	Mechanical rackless stage
Dimensions (width x depth)	140 mm x 135 mm	185 mm x 135 mm
Stage travel (X x Y)	75 mm x 40 mm	75 mm x 50 mm
Coaxial drive	short, right	long, right
Vernier scales	readable from right	readable from left
Specimen holder	with spring clip left	with spring clip left, for two slides

## Condensers

	Fixed-Köhler stand	Full-Köhler stand
Abbe condenser 0.9/1.25	for objective 4x to 100x	for objective 4x to 100x
Turret condenser BF/Ph1/Ph2/Ph3/DF	for objective 4x to 100x	for objective 4x to 100x

## Light sources

	Fixed-Köhler stand	Full-Köhler stand
Halogen lamp	–	HAL 6 V/30 W (changeable)
Adjustability	–	1.5 V to 6V DC
Color temperature	–	2,800 K (at 6V)
Luminous flux	–	280 lm
Average service life	–	1,000 h
Luminous area	–	1.5 mm x 3 mm
LED white light illumination	white light LED 3 W 5,600 K (fixed)	white light LED 3 W 5,600 K (changeable)
Peak wavelength	440 nm	440 nm
Homogeneous field illumination	20 mm	22 mm
Analogous brightness adjustment	approx. 15 to 100 %	approx. 15 to 100 %
Average operation lifetime	approx. 30,000 hours	approx. 35,000 hours

# Technical Specifications

- › In Brief
- › The Advantages
- › The Applications
- › The System
- › **Technology and Details**
- › Service

<b>Tubes</b>			
<b>Binocular (Photo)tubes</b>	<b>Binocular tube 25°/20</b>	<b>Binocular phototube 25°/20 (50:50)</b>	<b>Binocular phototube 25°/22 (50:50)</b>
Maximum field-of-view number	20	20	22
Interpupillary distance	adjustable from 48 mm to 75 mm	adjustable from 48 mm to 75 mm	adjustable from 48 mm to 75 mm
Viewing height	370 mm to 410 mm	370 mm to 410 mm	370 mm to 410 mm
Viewing port, tube factor	1×	1×	1×
Photo/video port, tube factor	–	1×	1×
Photo/video port, mount	–	60 mm	60 mm
Invariable splitting ratio	–	50 % vis and 50 % doc	50 % vis and 50 % doc

<b>Tubes</b>	
<b>Binocular tube with integrated camera</b>	<b>Binocular tube HD 25°/20 w/int cam 8MPx</b>
Maximum field-of-view number	22
Interpupillary distance	adjustable from 48 mm to 75 mm
Tube angle	25°
Viewing height	370 mm to 410 mm
Viewing port, tube factor	1×
<b>Integrated HD-CMOS camera</b>	

# Technical Specifications

- › In Brief
- › The Advantages
- › The Applications
- › The System
- › **Technology and Details**
- › Service

## Integrated 4K microscope camera

Sensor type	Sony CMOS image sensor color, Rolling Shutter
Sensor size	Image diagonal 8.1 mm, equivalent to 1/2.1" (7.1 mm × 4.0 mm)
Pixel count	3840 (H) × 2160 (V) = 8.3 MP, Ultra HD (4K)
Pixel size	1.85 μm × 1.85 μm
Bit depth	3 × 8 bit/pixel
Exposure range	0.06 ms up to 1 s
Gain	1× – 22× adjustable
Frame rate	HDMI: 30 fps Ethernet: 30 fps USB 3.0: up to 30 fps
Cooling system	Passive cooling
Spectral sensitivity	Approx. 400 nm – 700 nm, IR filter RGB Bayer color mask
Interface	HDMI, USB 3.0 Type C, Ethernet, Micro-D
Wi-Fi compatibility	Via USB Wi-Fi adapter and router
Power supply	External power supply provided, 9 W, compatibility to international sockets available
Operating system	for ZEN Imaging Software: Windows 10 ×64 Prof./Ultimate and higher for Labscope: Windows 7/10 ×64 Prof./Ultimate and iOS v11 and higher
Software	On Screen Display (OSD) for stand alone Labscope v2.9 (win), v2.8.3 (iOS) and higher ZEN (blue edition) v3.0 and higher TWAIN driver
Image enhancement functions	Active denoising, active sharpening, HDR
Automatic features	Automatic exposure and gain regulation at Ultra HD resolution (4K), auto white balance, fast live image under low light conditions



# Count on Service in the True Sense of the Word

- › In Brief
- › The Advantages
- › The Applications
- › The System
- › Technology and Details
- › **Service**

Because the ZEISS microscope system is one of your most important tools, we make sure it is always ready to perform. What's more, we'll see to it that you are employing all the options that get the best from your microscope. You can choose from a range of service products, each delivered by highly qualified ZEISS specialists who will support you long beyond the purchase of your system. Our aim is to enable you to experience those special moments that inspire your work.

## **Repair. Maintain. Optimize.**

Attain maximum uptime with your microscope. A ZEISS Protect Service Agreement lets you budget for operating costs, all the while reducing costly downtime and achieving the best results through the improved performance of your system. Choose from service agreements designed to give you a range of options and control levels. We'll work with you to select the service program that addresses your system needs and usage requirements, in line with your organization's standard practices.

Our service on-demand also brings you distinct advantages. ZEISS service staff will analyze issues at hand and resolve them – whether using remote maintenance software or working on site.

## **Enhance Your Microscope System.**

Your ZEISS microscope system is designed for a variety of updates: open interfaces allow you to maintain a high technological level at all times. As a result you'll work more efficiently now, while extending the productive lifetime of your microscope as new update possibilities come on stream.

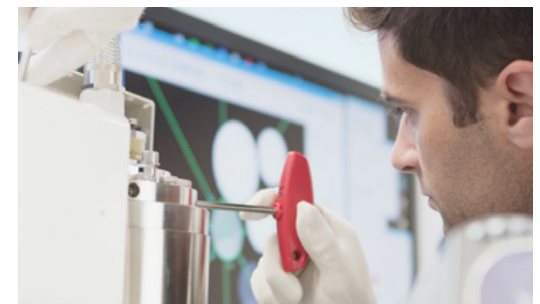

*Profit from the optimized performance of your microscope system with services from ZEISS – now and for years to come.*

>> [www.zeiss.com/microservice](http://www.zeiss.com/microservice)



**Carl Zeiss Microscopy GmbH**

07745 Jena, Germany  
microscopy@zeiss.com  
www.zeiss.com/primostar